



# The Product Guide

Sales Material  
Range  
Important Information  
Installation Guides

September 2024

Fax Order Line: 01827 316169



FS 681825



BS7619

Licence No. KM 33730



Fit Summit with Confidence  
[www.summitpvc.co.uk](http://www.summitpvc.co.uk)

**Sales Pages**

PVC Roofline \_\_\_\_\_ 4-5  
 Cladding \_\_\_\_\_ 6  
 Window Boards \_\_\_\_\_ 7

**Range & Price Guide**

**Roofline**

Fascias - Replacement \_\_\_\_\_ 8  
 Fascias - Overcapping \_\_\_\_\_ 9  
 Dry Verge Systems \_\_\_\_\_ 9  
 Roofline Joints & Corners \_\_\_\_\_ 10  
 Soffits - Vented \_\_\_\_\_ 11  
 Soffits - Plain \_\_\_\_\_ 11  
 Roof Trims \_\_\_\_\_ 12

**Cladding**

Cladding Boards \_\_\_\_\_ 13  
 Cladding Trims & Ventilation \_\_\_\_\_ 13

**Window Profiles**

Window Boards \_\_\_\_\_ 14  
 End Caps \_\_\_\_\_ 14  
 Reveal Liners \_\_\_\_\_ 15  
 Window Trims \_\_\_\_\_ 16  
 Skirtings & Architraves \_\_\_\_\_ 17  
 Plaslyne Angles & Rigid Window Boards \_\_\_\_\_ 17

**Foiled Profiles**

Claddings \_\_\_\_\_ 18-19  
 Fascias \_\_\_\_\_ 18-19  
 Soffits & Roof Trims \_\_\_\_\_ 20-21  
 Roof Trims \_\_\_\_\_ 20-21  
 Window Boards & Trims \_\_\_\_\_ 22-23  
 Plaslyne Angles and Kayboard \_\_\_\_\_ 24-25  
 Plaslyne Cills & Ancillaries \_\_\_\_\_ 26-27

**Important Information**

(H&S, Fixings, Ventilation etc) \_\_\_\_\_ 28 -29

**Installation Guides**

Roofline \_\_\_\_\_ 30-32  
 Window Boards \_\_\_\_\_ 33  
 Cladding \_\_\_\_\_ 34-35

# 20 year Extended Guarantee



**The Summit range of white cellular PVC fascias, soffits and claddings now has a leading 20 Year Extended Guarantee.**

The Summit 20 Year Extended Guarantee is available when Summit white cellular PVC roofline profiles are installed together with either a Swish or Kayflow white rainwater system.

In order to offer the new guarantee, installers must be registered at [www.summitpvc.co.uk](http://www.summitpvc.co.uk). where they can also register all their qualifying guarantees\*.

**Summit Standard Guarantees**

The Summit standard guarantee for white cellular PVC profiles has been extended to 15 years and the Guarantee for colour and foiled profiles remains at 10 Years.

\*For full terms and conditions please see the Summit Extended Guarantee at [www.summitpvc.co.uk](http://www.summitpvc.co.uk).

[www.summitpvc.co.uk](http://www.summitpvc.co.uk)

## Fit Summit with Confidence

- Will not discolour
- 20 Year Extended Guarantee available
- White, coloured and foiled products
- Class 1 fire rated to BS476:Part 7
- BSI Kitemarked
- Manufactured under ISO9001

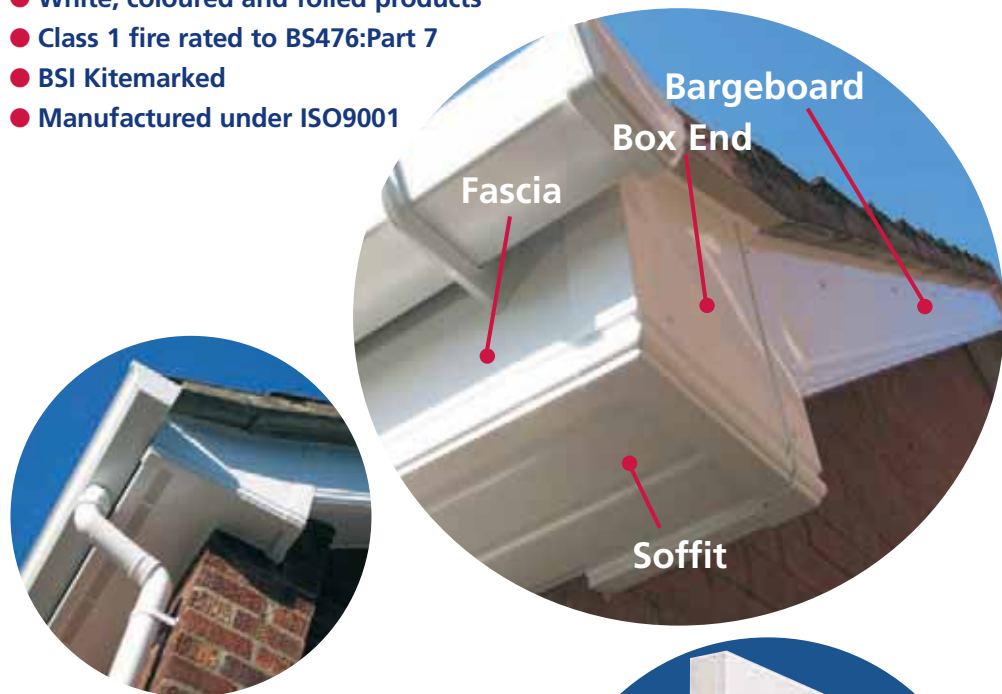

## ...and take it easy

- No Painting
- No Rot
- Easy to clean
- Long Life Span
- Recyclable

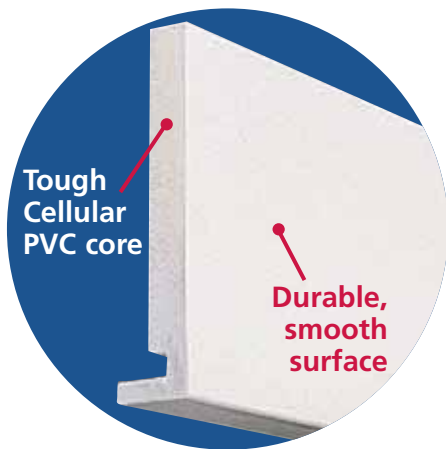

## Roofline

### Replacement Fascias

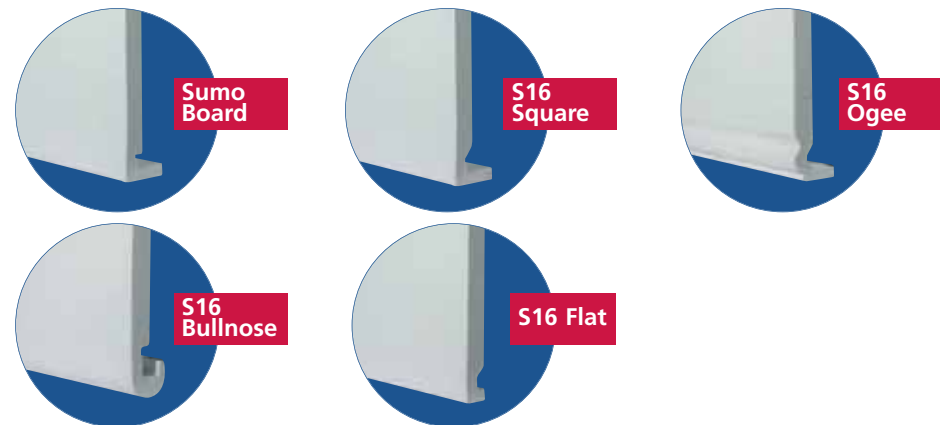

### Refurbishment Fascias



### Soffits



### Foiled Finishes

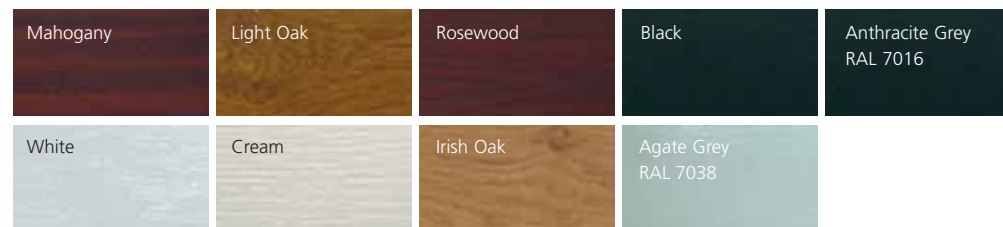

### Coloured Finishes

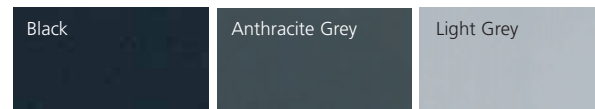

# PVC Cladding is an ideal replacement for timber



Dormers and Walls

Porches

Shiplap

Open V

Agate Grey  
RAL 7038

### Foiled Finishes

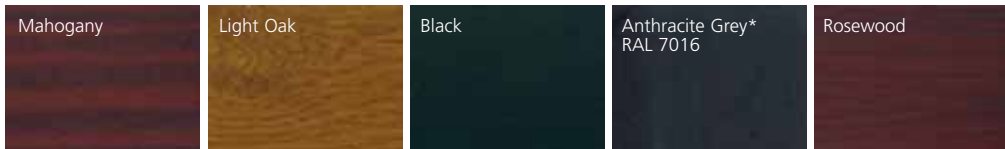

For colour availability in specific board styles and sizes see page 18

## Window Boards, Skirtings & Architraves



### Foiled Finishes

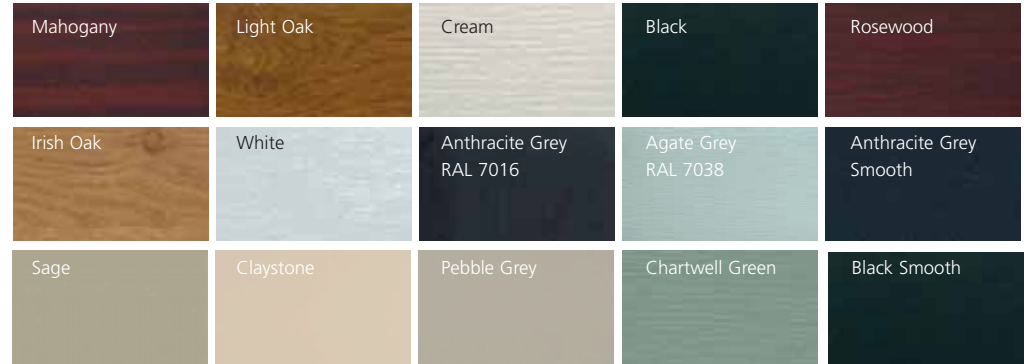

For colour availability in specific board styles and sizes see page 22.

## Plaslyne Cills and Keyboard

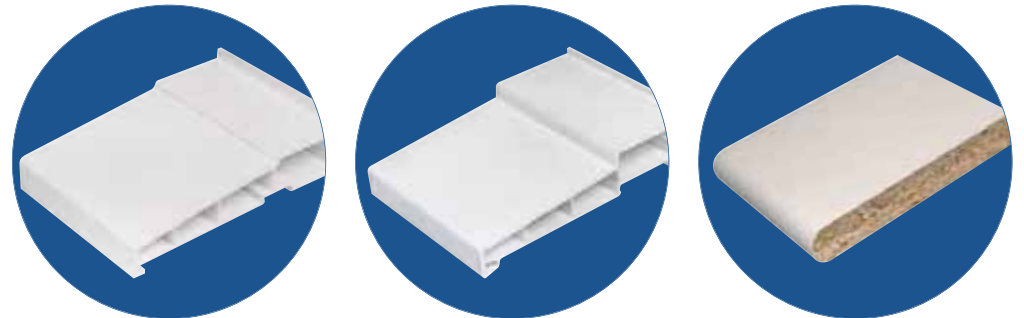

### Foiled Finishes

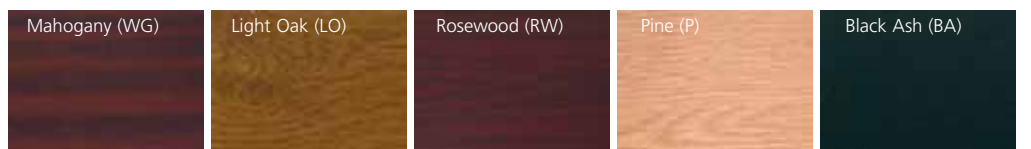

For colour availability see pages 24-26.

## Replacement Fascias

Size	Code No.	Pk Qty	W	Colour Code		
				G	A	E
<b>Sumo Board (20mm thick fascia)</b>						
150mm	PM150	2	•			
175mm	PM175	2	•			
200mm	PM200	2	•			
225mm	PM225	2	•			
250mm	PM250	1	•			
355mm (D/E)	PM355	1	•			
405mm (D/E)	PM405	1	•			
<b>S16 Square Fascia (16mm thick)</b>						
150mm	PU150	2	•	•	•	•
175mm	PU175	2	•	•	•	•
200mm	PU200	2	•	•	•	•
225mm	PU225	2	•	•	•	•
250mm	PU250	2	•	•	•	•
300mm	PU300	1	•	•	•	•
355mm (D/E)	PU355	1	•	•	•	•
405mm (D/E)	PU405	1	•	•	•	•
455mm (D/E)	PU455	1	•			
<b>S16 Ogee Fascia (16mm thick)</b>						
150mm	PZ150	2	•			
175mm	PZ175	2	•			
200mm	PZ200	2	•			
225mm	PZ225	2	•			
250mm	PZ250	2	•			
355mm (D/E)	PZ355	1	•			
405mm (D/E)	PZ405	1	•			
<b>S16 Bullnose Fascia (16mm thick)</b>						
150mm	PJ150	2	•			
175mm	PJ175	2	•			
200mm	PJ200	2	•			
225mm	PJ225	2	•			
250mm	PJ250	2	•			
355mm (D/E)	PJ355	1	•			
405mm (D/E)	PJ405	1	•			
455mm (D/E)	PJ455	1	•			
<b>S16 Flat Fascia (16mm thick)</b>						
150mm	PA150	2	•			
175mm	PA175	2	•			
200mm	PA200	2	•			
225mm	PA225	2	•			
250mm	PA250	2	•			
405mm (D/E)	PA405	1	•			

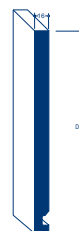
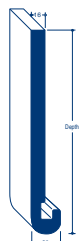

## Refurbishment Fascias

Size	Code No.	Pk Qty	W	G	Colour Code	
					A	E
<b>Cover Board (9mm thick) 35mm Leg</b>						
100mm	PR100	2	•			
150mm	PR150	2	•			
175mm	PR175	2	•	•	•	•
200mm	PR200	2	•	•	•	•
225mm	PR225	2	•	•	•	•
250mm	PR250	2	•	•	•	•
300mm	PR300	2	•			
400mm	PR400	1	•			
405mm (D/E)	PR405	1	•	•	•	•
605mm	PR605	1	•			
<b>Ogee Fascia (9mm thick + ribs) 35mm Leg</b>						
150mm	PY150	2	•			
175mm	PY175	2	•			
200mm	PY200	2	•			
225mm	PY225	2	•			
250mm	PY250	2	•			
405mm (D/E)	PY405	1	•			
<b>Cover Board (7mm) 42mm Leg</b>						
150mm	PP150	4	•			
175mm	PP175	4	•			
200mm	PP200	4	•			
225mm	PP225	4	•			
250mm	PP250	4	•			
354mm (D/E)	PP354	2	•			
455mm (D/E)	PP455	2	•			

D/E = Double-ended W = Standard White, G = Anthracite Grey, A = Black, E = Light Grey

## Dry Verge Systems

Size	Code No.	Colour Code	Pk Qty
<b>Verge Master - Handed</b>			
Verge Unit Left	DVLH**50	GR/BR/BL	50
Verge Unit Right	DVRH**50	GR/BR/BL	50
Starter Unit Left	DVLHS**30	GR/BR/BL	30
Starter Unit Right	DVRHS**30	GR/BR/BL	30
Angled Ridge Cap	DVRCA**10	GR/BR/BL	10
Round Ridge Cap	DVRCR**10	GR/BR/BL	10
Batten End Clip	DVBEC50*		50
<b>Verge Wizard - Universal</b>			
Verge Unit	DVU**60	GR/BR/BL	60
Starter Unit	DVUS**30	GR/BR/BL	30
Angled Ridge Cap	DVRCA**10	GR/BR/BL	10
Round Ridge Cap	DVRCR**10	GR/BR/BL	10
Batten End Clip	DVBEC50*		50

\* The batten end clip is stainless steel and not coloured \*\* Please enter colour code here when ordering  
More information can be found at [www.dryvergesystems.co.uk](http://www.dryvergesystems.co.uk) GR = Grey BR = Brown BL = Black

## Corners and Joints

Description	Code No.	Pk Qty	Lgth	W	G	Colour Code		
						A	E	
<b>Joints</b>								
Sumo (D/E)	C153	2	500	•				
S16 Square (D/E)	C326	2	500	•	•	•	•	
S16 Bullnose (D/E)	C328	2	500	•				
S16 Ogee (D/E)	C329	2	500	•				
S16 Flat (D/E)	C327	2	500	•				
Cover Board (D/E)	C302	2	500	•				
Square	C235	10	300	•	•	•	•	
Ogee	C236	10	300	•				
S16 Bullnose	C299	10	300	•				
<b>External Corners</b>								
Sumo (D/E)	C154	2	500	•				
S16 Square (D/E)	C415	2	500	•	•	•	•	
S16 Bullnose (D/E)	C418	2	500	•				
S16 Ogee (D/E)	C417	2	500	•				
Cover Board (D/E)	C294	2	500	•				
Square	C232	10	300	•	•	•	•	
Ogee	C233	10	300	•				
S16 Bullnose	C301	10	300	•				
<b>Internal Corners</b>								
Square	C298	2	500	•	•	•	•	
Ogee	C300	2	500	•				
Bullnose	C321	2	500	•				
<b>135° Corners</b>								
Sq/Ogee Ext	C492	5	410	•				
Sq/Ogee Int	C493	5	410	•				
<b>7mm Corners &amp; Joints</b>								
Square Joint	PCT350	10	362	•				
Square Corner	PCC350	10	362	•				
Square Joint	PCT450	10	450	•				
Square Corner	PCC450	10	450	•				
(for use with 7mm boards ONLY)								

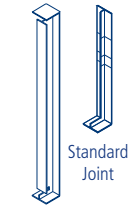

Standard Joint  
Full Depth Joint D/E

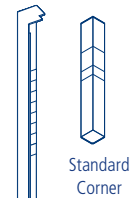

Standard Corner  
Face Fix Corner



Internal Corner

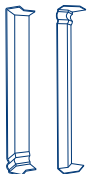

External/Internal Corners



7mm Corners and Joints

D/E = Double-ended

W = Standard White, G = Anthracite Grey, A = Black, E = Light Grey

## Soffits and Roof Trims

Size	Code No.	Pk Qty	W	G	Colour Code		
					A	E	
<b>Vented Soffit (9mm) - (A)</b>							
150mm	PV150	2	•	•	•		
175mm	PV175	2	•	•	•		
200mm	PV200	2	•				
225mm	PV225	2	•	•	•		
250mm	PV250	2	•				
300mm	PV300	2	•	•	•		
405mm	PV405	1	•	•	•		
450mm	PV450	1	•				
605mm	PV605	1	•				
<b>Vented Soffit (9mm) - (B)</b>							
150mm	PX150	2	•				
225mm	PX225	2	•				
300mm	PX300	2	•				
450mm	PX450	1	•				
<b>Flat Boards (9mm)</b>							
100mm*	PF101	5	•				
100mm	PF100	5	•				
150mm	PF150	2	•	•	•	•	•
175mm	PF175	2	•	•	•	•	•
200mm	PF200	2	•	•	•	•	•
225mm	PF225	2	•	•	•	•	•
250mm	PF250	2	•	•	•	•	•
300mm	PF300	2	•	•	•	•	•
405mm*	PF405	1	•	•	•	•	•
450mm	PF450	1	•				
500mm	PF500	1	•				
605mm*	PF605	1	•	•	•	•	•



\* 2 finished edges

(A) Suitable for roof pitch >15°. Air gap equivalent to continuous 10mm

(B) Suitable for roof pitch <15°. Air gap equivalent to continuous 25mm

W = Standard White, G = Anthracite Grey, A = Black, E = Light Grey

## Soffits and Roof Trims

Size	Code No.	Pk Qty	W	A	B	Colour Code G	E	Z <sup>A</sup>
------	----------	--------	---	---	---	---------------	---	----------------

### Hollow Soffit

100mm	H100	10	•					
250mm**	H250	4	•					
300mm	H300	4	•					
Starter/Edge Trim	HST	10	•					
Joint Trim	HJT	10	•					
100mm	J100	10	•					
300mm	J300	5	•	•	•			
Starter/Edge Trim	JST	10		•	•	•		
Joint Trim	JJT	10		•	•	•		
250mm	RSB250	5	•					
300mm	RCH300	5	•					
300mm	SUB300	5	•	•	•	•		

### Roof Trims

25mm Angle **	PA020	20	•					
50mm Angle	PA050	10	•					
Hollow Angle (80 x 100mm)	PA080	5	•					
Felt Roof Edge Trim	C038	10	•					
Edge Trim	C039	10	•					
Soffit Joint	C041	10	•	•		•	•	
Gable Finial	C459	10	•					

### Over Fascia Protection & Ventilation

Over Fascia Protector (2.5m lengths)	C502	5						•
Vented Eaves Protector (1m lengths) *	C406	40						•
Bird Comb * (1m lengths - attaches to C406)	C405	30						•

\* Suitable for roof pitch >15°.

Air gap equivalent to continuous 10mm

\*\* Not illustrated

W = Standard White, A = Black, B = Brown, Z<sup>A</sup> = Black (Not Foiled), G = Anthracite Grey, E = Light Grey

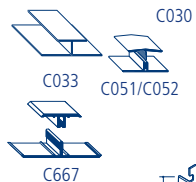
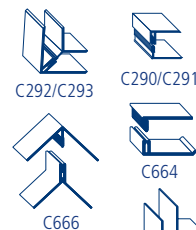
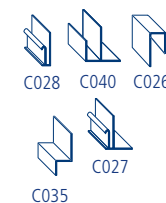
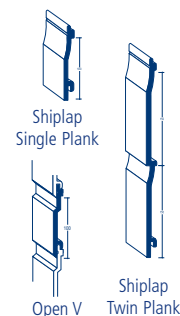
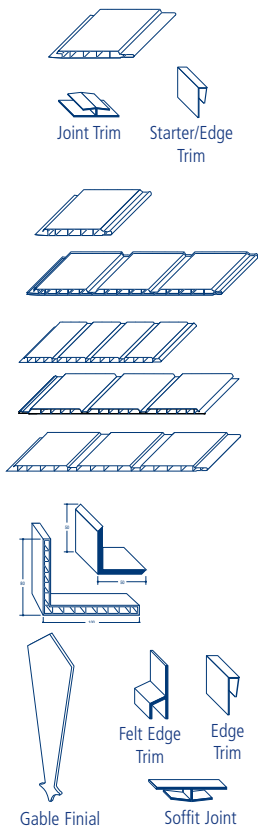

Shiplap and Open V Joint Covers

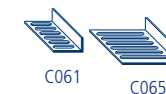

## Cladding

Size/Description	Code No.	Colour Code W	Pk Qty
------------------	----------	---------------	--------

100mm Shiplap	PS100	•	5
150mm Shiplap	PS150	•	5
150mm TWIN Shiplap	PS300	•	2
100mm Open V	PW101	•	5

## Cladding Trims

### General Trims

Universal Channel	C026	•	10
Universal Channel & Batten Cover	C040	•	10
Wall Starter Trim	C028	•	10
Starter Trim & Batten Cover	C027	•	10
Drip Trim	C035	•	10

### Corners

Universal Trim (M)*	C290	•	10
Universal Trim (F)*	C291	•	10
Universal Trim (M&F)*	C664	•	10 (5 pairs)
Corner Trim (M)*	C292	•	5
Corner Trim (F)*	C293	•	5
Corner Trim (M&F)*	C666	•	10 (5 pairs)
Ext. Corner	C030	•	5

\* 2-Part Trims

(M) = Male, (F) = Female

### Joints

Joint Trim (M)*	C051	•	5
Joint Trim (F)*	C052	•	5
Joint Trim (M&F)*	C667	•	10 (5 pairs)
Centre Joint	C033	•	5
100mm Shiplap Joint	C042	•	10
150mm Shiplap Joint	C043	•	10
100mm Open V Joint	C281	•	10
300mm Shiplap Joint	C045	•	5

\* 2-Part Trims

(M) = Male, (F) = Female

### Ventilators

30 x 15mm Vent	C061	•	5
60 x 15mm Vent	C065	•	5

W = Standard White

## Window Boards/Reveals

Size	Code No.	Pk Qty	W	G	Colour Code	
					A	E
<b>Bullnose Window Board (16mm)</b>						
150mm	PJ150	2	•			
175mm	PJ175	2	•			
200mm	PJ200	2	•			
225mm	PJ225	2	•			
250mm	PJ250	2	•			
355mm (D/E)	PJ355	1	•			
405mm (D/E)	PJ405	1	•			
455mm (D/E)	PJ455	1	•			
End Cap (300mm)	C209	20	•			
<b>Reveal/Cover Board (9mm) 35mm Leg</b>						
100mm	PR100	2	•			
150mm	PR150	2	•			
175mm	PR175	2	•	•	•	•
200mm	PR200	2	•	•	•	•
225mm	PR225	2	•	•	•	•
250mm	PR250	2	•			
300mm	PR300	2	•			
400mm	PR400	1	•			
405mm (D/E)	PR405	1	•	•	•	•
605mm	PR605	1	•			
End Cap (50mm)	C212	20	•			
End Cap (300mm)	C278	10	•			
<b>Bullnose Window Board (9mm)</b>						
150mm	PN150	2	•			
175mm	PN175	2	•			
200mm	PN200	2	•			
225mm	PN225	2	•			
250mm	PN250	2	•			
300mm	PN300	2	•			
405mm	PN405	1	•			
End Cap (300mm)	C048	10	27.45 pk	-	-	-
End Cap (135mm)	C050	5	12.98 pk	-	-	-

D/E = Double-ended

W = Standard White, A = Black, G = Anthracite Grey, E = Light Grey



## Window Boards/Reveals

Size	Code No.	Pk Qty	W	G	Colour Code	
					A	E
<b>Reveal/Cover Board (7mm) 42mm Leg</b>						
150mm	PP150	4	•			
175mm	PP175	4	•			
200mm	PP200	4	•			
225mm	PP225	4	•			
250mm	PP250	4	•			
354mm (D/E)	PP354	2	•			
455mm (D/E)	PP455	2	•			
End Cap (100mm)	C138	10	•			
End Cap (300mm)	C199	10	•			
<b>Flat Boards (9mm)</b>						
100mm*	PF101	5	•			
100mm	PF100	5	•			
150mm	PF150	2	•	•	•	•
175mm	PF175	2	•			
200mm	PF200	2	•	•	•	•
225mm	PF225	2	•			
250mm	PF250	2	•			
300mm	PF300	2	•	•	•	•
405mm*	PF405	1	•	•	•	•
450mm	PF450	1	•			
500mm	PF500	1	•			
605mm*	PF605	1	•	•		
* 2 finished edges						
Window Board Channel	C037	20	•			

W = Standard White, A = Black, G = Anthracite Grey, E = Light Grey



## Window Trims

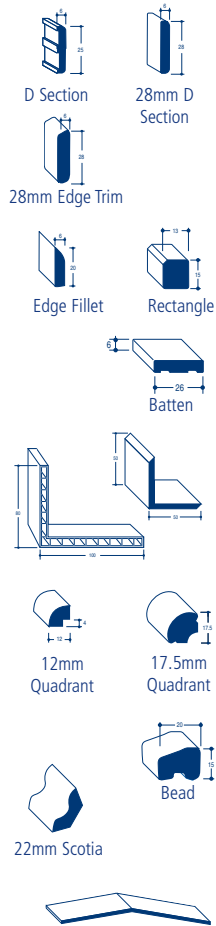

Size/Description	Code No.	Pk Qty	Colour Code W
<b>Window Trims</b>			
25mm D Section	PD025	25	•
28mm D Section*	PD028	25	•
28mm Edge Trim	PE028	25	•
50mm D Section	PE050	10	•
75mm D Section	PE075	10	•
* Flat-backed version			
<b>Window Trims</b>			
20mm Edge Fillet	PE020	25	•
15 x 13mm Rect	PA015	25	•
25 x 20mm Rect	PA025	10	•
26 x 6mm Batten	PA026	25	•
<b>Window Trims</b>			
25mm Angle	PA020	20	•
50mm Angle	PA050	10	•
80x100mm Angle	PA080	5	•
<b>Window Trims</b>			
12mm Quadrant	PQ012	20	•
17.5mm Quadrant	PQ017	20	•
20 x 15mm Bead	PQ020	20	•
<b>Window Trims</b>			
22mm Scotia	PQ025	20	•
<b>Window Trims</b>			
50mm Flexi-Angle	PD045	10	•
75mm Flexi-Angle	PD075	10	•

W = Standard White

## Skirtings & Architraves

Size/Description	Code No.	Pk Qty	Colour Code W
<b>6mm Thick</b>			
45mm Architrave	PG045	10	•
70mm Skirting	PG070	10	•
95mm Skirting	PG095	5	•
<b>Castellated</b>			
45mm Architrave	PB045	10	•
70mm Skirting	PB070	10	•
95mm Skirting	PB095	5	•
<b>7.5mm Thick</b>			
35mm Architrave	PC035	10	•
50mm Architrave	PC050	10	•
75mm Skirting	PC075	10	•
100mm Skirting	PC100	5	•
125mm Skirting	PC125	5	•
<b>12mm Thick</b>			
45mm Architrave	PC045	10	•
70mm Skirting	PC070	10	•
95mm Ogee Skirt.	PC095	5	•
<b>Decorative Profiles</b>			
70mm	C730	5	•
125mm	C731	5	•

## Plaslyne Angles & Rigid Window Boards

	Code No.	Std Lgth	Pk Qty	Colour Code (B)
<b>Angles</b>				
23 x 65mm Solid Angle	PSA23X65	5	10	•
25 x 25mm Solid Angle	PSA25X25	5	20	•
32 x 32mm Solid Angle	PSA32X32	5	10	•
40 x 40mm Solid Angle	PSA40X40	5	20	•
50 x 50mm Solid Angle	PSA50X50	5	10	•
60 x 60mm Solid Angle	PSA60X60	5	10	•
80 x 80mm Solid Angle	PSA80X80	5	5	•
100 x 100mm Solid Angle	PSA100X100	5	5	•
<b>Angles</b>				
50mm Flexi Angle	PFL50	5	10	•
75mm Flexi Angle	PFL70	5	10	•
100mm Flexi Angle	PFL100	5	10	•
150mm Flexi Angle	PFL150	5	5	•
<b>Rigid Window Boards - Square (3mm thick)</b>				
175mm	PWB175	5	2	•
245mm	PWB245	5	2	•
100mm End Cap	PWBBCAP		50	•

W = Standard White, B = Brilliant White

# Cladding and Fascia Systems (Foiled finishes)

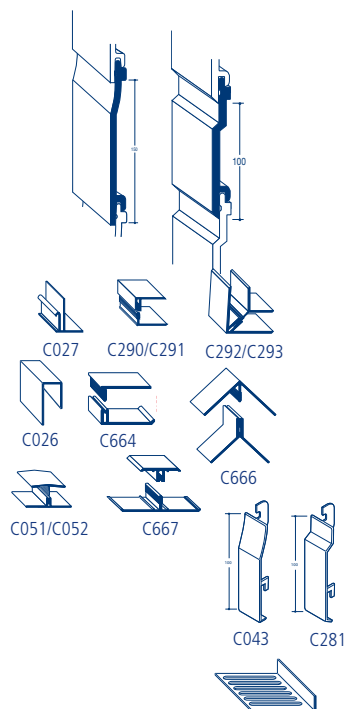

## Cladding System

Claddings and Trims	Code No:	Pk Qty	(M)	(C)	(R)	Price per length £					
						(Q)	(Z)	(X)	(AG)	(K)	(D)
150mm Shiplap	C002	5	•	•	•	•	•	•	•		
100mm Open V	C269	5	•	•	•	•	•	•	•		
Universal Channel	C026	5	•	•	•	•	•	•	•		
2-Part Universal Trim (M) (Use C291 White Female - P.13)	C290	5	•	•	•	•	•	•	•		
2-Part Universal Trim (Male & Female)	C664	10 (5 pairs)	•	•	•	•	•	•	•		
2-Part Corner Trim (F) (Use C292 White Male - P.13)	C293	5	•	•	•	•	•	•	•		
2-Part Corner Trim (Male & Female)	C666	10 (5 pairs)	•	•	•	•	•	•	•		
2-Part Joint (M) (Use C052 White Female - P.13)	C051	5	•	•	•	•	•	•	•		
2-Part Joint (Male & Female)	C667	10 (5 pairs)	•	•	•	•	•	•	•		
150mm Shiplap Joint	C043	10	•	•	•	•	•	•	•		
100mm Open V Joint	C281	10	•	•	•	•	•	•	•		
60 x 15mm Angle Ventilator*	C065	5	•				•				
25mm Ventilator*	C238	5	•				•				
Universal Starter Trim*	C027	10	•				•				

\* Not foiled - use plain colour codes: A=Black B=Brown

## Fascia and Bargeboards

### Square Fascia (16mm)

150mm	C345	2	•	•	•	•	•	•	•	•	•
175mm	C346	2	•	•	•	•	•	•	•	•	•
200mm	C347	2	•	•	•	•	•	•	•	•	•
225mm	C348	2	•	•	•	•	•	•	•	•	•
250mm	C349	2	•	•	•	•	•	•	•	•	•
300mm	C365	1	•	•	•	•	•	•	•	•	•
405mm (D/E)	C351	1	•	•	•	•	•	•	•	•	•

### Tudor Board (20mm) - no soffit groove

150mm	C540	2	•	•	•	•	•	•	•	•	•
-------	------	---	---	---	---	---	---	---	---	---	---

### Reveal/Cover Board (9mm)

150mm	C107	2	•	•	•	•	•	•	•	•	•
175mm	C095	2	•	•	•	•	•	•	•	•	•
200mm	C217	2	•	•	•	•	•	•	•	•	•
225mm	C120	2	•	•	•	•	•	•	•	•	•
250mm	C098	2	•	•	•	•	•	•	•	•	•
300mm	C104	2	•	•	•	•	•	•	•	•	•
405mm (D/E)	C150	1	•	•	•	•	•	•	•	•	•

D/E = Double-ended

M = Mahogany C = Light Oak R = Rosewood Q = Irish Oak Z = Black  
X = Anthracite Grey K = White D = Cream AG = Agate Grey

9mm reveal cover board in foiled and colour finishes is not suitable for use as a fascia board or bargeboard

# Roofline System (Foiled finishes)

## Soffit and Roof Trims



### Vented Soffit (9mm)

	Code No:	Pk Qty	(M)	(C)	Available colours					
			(R)	(Q)	(Z)	(X)	(AG)	(K)	(D)	
150mm	C305	2	•	•	•	•	•	•	•	
175mm	C306	2	•	•	•	•	•	•	•	
225mm	C397	2	•	•	•	•	•	•	•	
300mm	C308	2	•	•	•	•	•	•	•	
405mm	C410	1	•	•	•	•	•	•	•	



### Flat Soffit (9mm)

100mm	C239	5	•	•	•	•	•	•	•
150mm	C240	2	•	•	•	•	•	•	•
175mm	C241	2	•	•	•	•	•	•	•
200mm	C244	2	•	•	•	•	•	•	•
225mm	C245	2	•	•	•	•	•	•	•
250mm	C253	2	•	•	•	•	•	•	•
300mm	C246	2	•	•	•	•	•	•	•
405mm	C248	1	•	•	•	•	•	•	•
Soffit Joint	C041	2	•	•	•	•	•	•	•

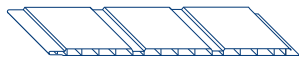

### Hollow Soffit

300mm Hollow Soffit	VHS300	5	•	•	•	•	•	•	•
Starter/Edge Trim	HST	10	•	•	•	•	•	•	•
Joint Trim	HJT	10	•	•	•	•	•	•	•
250mm Hollow Soffit	RSB250	5	•	•	•	•	•	•	•



### Roof Trims

			Price per pack £						
Square Joint (300mm)	C235	10	•	•	•	•	•	•	•
90° Square Cnr (300mm)	C232	10	•	•	•	•	•	•	•
Square Joint (500mm) D/E	C326	2	•	•	•	•	•	•	•
Square Ext. Cnr (500mm) D/E	C415	2	•	•	•	•	•	•	•
Square Int.l Cnr (500mm) D/E	C298	2	•	•	•	•	•	•	•
Gable Finial	C459	5	•	•	•	•	•	•	•

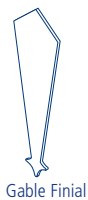
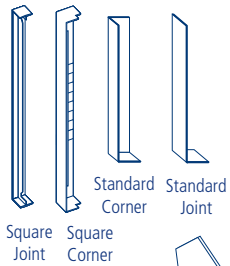

D/E = Double-ended

M = Mahogany C = Light Oak R = Rosewood

Q = Irish Oak Z = Black X = Anthracite Grey K = White D = Cream AG = Agate Grey

## Window Boards and Trims (Foiled finishes)

### Window Boards

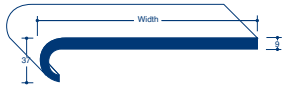

	Code No.	Pk Qty	(M)	(C)	(R)	(Q)	(K)	Price per length £								
								(D)	(Z)	(X)	(L)	(SX)	(U)	(O)	(I)	
<b>Bullnose Window Board (9mm)</b>																
175mm	C261	2	•	•	•	-	-	-	-	-	-	-	-	-	-	-
225mm	C263	2	•	•	•	-	-	-	-	-	-	-	-	-	-	-
Price per pack £																
B/Nose End Cap (300mm) Foiled	C047	10	•	•	•	-	-	-	-	-	-	-	-	-	-	-
B/Nose End Cap (135mm)	C050	5	•	•	•	-	-	-	-	-	-	-	-	-	-	-
Price per length £																



	Code No.	Pk Qty	(M)	(C)	(R)	(Q)	(K)	(D)	(Z)	(X)	(L)	(SX)	(AG)			
<b>Reveal/Cover Board (9mm) 35mm Leg</b>																
150mm	C107	2	•	•	•	-	-	-	•	•	-	-	•			
175mm	C095	2	•	•	•	•	•	•	•	•	-	-	•			
200mm	C217	2	•	•	•	-	-	-	•	•	-	-	•			
225mm	C120	2	•	•	•	•	•	•	•	•	-	-	•			
250mm	C098	2	•	•	•	-	-	-	•	•	-	-	•			
300mm	C104	2	•	•	•	-	-	-	•	•	-	-	•			
405mm (Double-Ended)	C150	1	•	•	•	-	-	•	•	•	-	-	•			
Price per pack £																
Reveal End Cap (50mm)	C212	20	•	•	•	•	-	-	-	-	-	-	-			
Reveal End Cap (300mm)	C279	1	•	•	•	•	-	-	•	-	-	-	-			

### Window Trims, Skirtings & Architraves

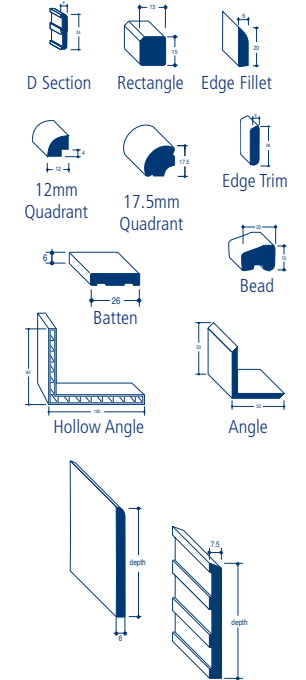

	Code No.	Pk Qty	(M)	(C)	(R)	(Q)	(K)	Price per length £									
								(D)	(Z)	(X)	(L)	(SX)	(AG)	(U)	(O)	(I)	(SZ)
<b>Window Trims</b>																	
25mm D Section	C205	25	•	•	•	•	•	•	•	•	•	•	•	-	-	-	•
28mm D Mould (flat back)	C745	10	-	-	-	-	-	-	-	-	-	-	-	•	•	•	•
20mm Edge Fillet	C016	25	•	•	•	•	•	-	-	-	•	•	•	-	-	-	•
28mm Edge Trim	C014	10	-	•	•	-	-	-	-	-	-	-	-	•	•	•	•
15 x 13mm Rectangle	C019	25	•	-	-	-	-	-	-	-	-	•	-	-	-	-	-
25 x 20mm Rectangle	C012	10	•	•	•	•	•	•	•	•	•	•	•	-	-	-	•
26 x 6mm Batten	C015	25	-	•	•	-	-	-	-	-	-	-	-	-	-	-	-
12mm Quadrant	C021	20	•	•	•	-	-	-	•	•	-	-	-	-	-	-	-
17.5mm Quadrant	C216	20	•	•	•	•	•	•	•	•	•	•	•	-	-	-	•
18mm Quadrant	C755	10	•	•	•	•	•	•	•	•	•	•	•	•	•	•	•
20 x 15mm Bead	C011	20	-	•	•	-	-	-	-	-	-	-	-	-	-	-	-
25 x 25mm Angle	C018	20	•	•	•	-	-	-	•	•	-	-	-	-	-	-	-
50 x 50mm Angle	C056	10	•	•	•	-	-	-	•	•	-	-	-	-	-	-	-
100 x 80mm Hollow Angle	C020	5	-	•	•	-	-	-	•	•	-	-	-	-	-	-	-
<b>Skirtings &amp; Architraves</b>																	
45mm Architrave (5.5mm)	C715	4	-	-	-	-	-	-	-	-	-	-	-	•	•	•	-
65mm Skirting (5.5mm)	C725	4	-	-	-	-	-	-	-	-	-	-	-	•	•	•	-
95mm Skirting (5.5mm)	C735	4	-	-	-	-	-	-	-	-	-	-	-	•	•	•	-
45mm Architrave (6mm) Flat	C254	10	•	•	•	•	•	•	•	•	•	•	•	-	-	-	•
70mm Skirting (6mm) Flat	C258	10	•	•	•	•	•	•	•	•	•	•	•	-	-	-	•
95mm Skirting (6mm) Flat	C259	5	•	•	•	•	•	•	•	•	•	•	•	-	-	-	•
50mm Architrave (7.5mm)	C022	10	•	-	-	-	-	-	-	-	-	-	-	-	-	-	-
75mm Skirting (7.5mm)	C023	10	•	-	-	-	-	-	-	-	-	-	-	-	-	-	-
100mm Skirting (7.5mm)	C024	5	•	-	-	-	-	-	-	-	-	-	-	-	-	-	-

M = Mahogany C = Light Oak R = Rosewood Q = Irish Oak Z = Black X = Anthracite Grey  
 SZ = Black Smooth

L = Chartwell Green K = White D = Cream SX = Anthracite Grey Smooth U = Sage O = Claystone I = Pebble Grey AG = Agate Grey

## Plaslyne Angles and Keyboard

### Plaslyne Angles



	Code No.	Std Lgth	Pk Qty	(W)	Price per length £			(BA)	(P)	(X)
					(WG)	(LO)	(RW)			
<b>Angles</b>										
25 x 25mm Solid Angle	PSA25X25	5	20							
32 x 32mm Solid Angle	PSA32X32	5	10		•	•	•	•		
50 x 50mm Solid Angle	PSA50X50	5	10			•	•	•	•	

### Keyboard Laminated Window Boards



**Important Information:**  
Keyboard internal window boards are Melamine laminate, bonded to a P3 moisture resistant chipboard core.

	Code No.	Std Lgth	Pack Qty	(W)	Price per length £			(BA)	(P)	(X)
					(WG)	(LO)	(RW)			
<b>Bullnose (22mm thick)</b>										
150mm	KB150	5	1	•		•	•			
180mm	KB180	5	1	•		•	•	•		
200mm	KB200	5	1	•	•	•	•	•		
225mm	KB225	5	1	•	•	•	•	•		
250mm	KB250	5	1	•	•	•	•	•		
300mm	KB300305	3.05	1	•		•	•	•		
300mm	KB300	5	1	•		•	•	•		
600mm	KB6003	3.05	1	•		•	•	•		
900mm	KB900	3.05	1	•						

Price per pack £

### Accessories

	Code No.	Pack Qty	(W)	Price per length £			(BA)	(P)	(X)
				(WG)	(LO)	(RW)			
End Cap (Plain)	KBEC	10 Pairs	•	•	•				
Internal Mitre Joint (Plain)	KBMS	10 Pairs	•	•	•				
External Mitre Joint (Plain)	KBEMS	10 Pairs	•						

Use WG for Rosewood & LO for Pine



Skirting and Architrave profiles are polyester laminate bonded to a moisture resistant MDF core.

	Code No.	Std Lgth	Pk Qty	(W)	Price per length £			(BA)	(P)	(X)
					(WG)	(LO)	(RW)			
<b>Skirtings and Architraves</b>										
68mm Ogee	KA68	4.4	1	•		•		•		
94mm Torus	KS94	4.4	1	•		•		•		
144mm Torus	KS144	4.4	1	•		•		•		

W = White WG = Mahogany LO = Light Oak  
RW = Rosewood P = Pine X = Anthracite Grey

# Cill Systems

## Plaslyne Cills and Ancillaries

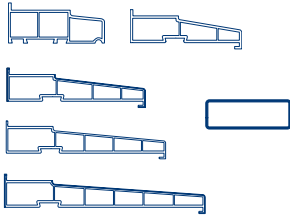

	Code	Std Length	Pack Qty	(B)	(WG)	Price per Length £					
						(LO)	(RW)	(BR)	(BA)	(BL)	
<b>Standard Cills (60mm System)</b>											
85mm	PC85	5m	2	•*		•	•				
125mm	PC125	5m	2	•*	•	•	•				
155mm	PC155	5m	2	•*	•	•	•		•		
180mm	PC180	5m	2	•*	•	•	•				
225mm	PC225	5m	2	•*	•	•	•				
Reinforcement	PCRCM	5m	1	(W) •	Recycled composite material fits inside cill.						
Price per Pack £											

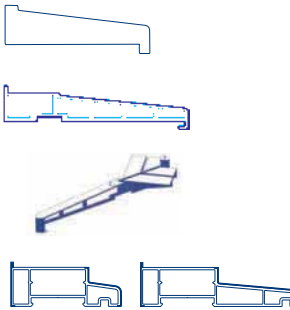

<b>Ancillaries for Standard Cills (60mm System)</b>										
End Cap 85mm Plain	PC85*CAP		Box 100	•*	•*	•*				
End Cap 125mm Plain	PC125*CAP		Box 100	•*	•*					
End Cap 155mm Plain	PC155*CAP		Box 100	•*	•*	•*			•*	
End Cap 180mm Plain	PC180*CAP		Box 100	•*	•*	•*				
End Cap 225mm Foiled	PC225*CAP		Box 50	•*	•*	•				
				(W)						
Straight Joint 155mm (1) Plain	PCJ155		Pack 10	•*	-	•*	-	-	-	-
Straight Joint 180mm (2) Plain	PCJ180		Pack 10	•*		-		•*		
Angled Joint 135° (3) Plain	P155135		Pack 10	•*				•*		
Angled Joint 90° (3) Plain	P15590		Pack 10	•*		•*		•*		
Price per Length £										

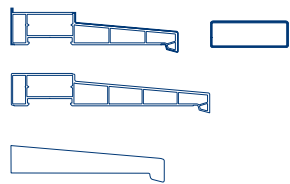

<b>Large Platform Cills (70mm System)</b>											
85mm	PL85	5m	2	•*	•	•	•				
125mm	PL125	5m	2	•*							
155mm	PL155	5m	2	•*	•	•	•				
185mm	PL185	5m	2	•*		•	•				
Reinforcement	PLRCM	5m	1	(W) •	Recycled composite material fits inside cill.						
Price per Pack £											

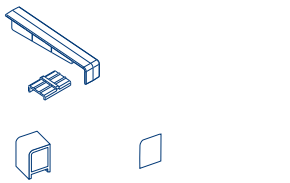

<b>Ancillaries for Large Format Cills (70mm System)</b>										
End Cap 85mm Plain	PL85*CAP		Box 100	•*	•*	•*				
Universal End Cap Plain	PL*CAP		Box 50	•*	•*	•*			•*	
Straight Joint Plain	PLCJ		Pack 10	•*	•*	•*				
Straight Joint 90° Plain	PLCJ90		Pack 10	•*	•*	•*				
Universal Joint 120° – 150° Plain	PLCJU		Pack 10	•*	•*	•*				



<b>Ancillary Profiles</b>										
Drip Bar	PDB	5m	10	•*						
Drip Bar End Cap	PDBBCAP		Box 100	•*						
Description	Code	Length	Std Qty	Pack	(WGW)	Price per Length £			(BAW)	
						(LOW)	(RWW)			

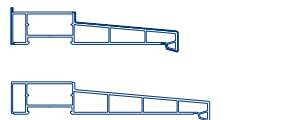

<b>Large Platform Cills (70mm System) Extended Colour Range</b>										
85mm	PL85	5m	2			•	•			
155mm	PL155	5m	2		•	•	•		•	
185mm	PL185	5m	2						•	

(1) Cut to fit 85 & 125  
 (2) Cut to fit 85, 125 & 155  
 (3) Suitable for all 155mm cills

B = Brilliant White W = White WG = Mahogany LO = Light Oak RW = Rosewood BA = Black Ash BR = Brown Colour BL = Black Colour  
 "W" added to the code denotes the foil colour on a white base  
 \* This product is coloured NOT foiled

## Access Systems

SAFETY FIRST!

Never attempt to access the work area with an unsupported ladder or without a stable deck. Always use a full scaffold platform or a purpose made cantilevered deck system with guard rails in place.

## Health and Safety

Full health and Safety information is available on request.

## Storage & Handling

Load and unload by hand and support both ends of a 5m length when handling. Stack no higher than 1m, in packing sleeve on a flat base. Avoid contact with solvents, paint, creosote, bitumen etc.

## Cutting/Shaping

Use conventional carpentry tools including fine toothed saws.

Power tools may be run at speeds appropriate for timber.

Nail and screw holes do not require pre-drilling.

## Fascia Boards

Summit Sumo, S16 boards and foiled boards are able to support the weight of the lower row of tiles without the need for a tilt fillet or kick plate.

## Fixings

A4 grade stainless steel plastic headed nails or capped screws.

	Fixing	Code	Size	Qty	Max Centres
<b>Roofline</b>					
Sumo/S16	Nail	C083	65mm	2	White 600mm Foiled 400mm Coloured 400mm
	Screw	C072	50mm	2	
9mm Cover Boards	Nail	C082	50mm	2	
	Screw	C071	40mm	2	
Flat Boards	Nail	C081	40mm	2	
	Screw	C071	40mm	2	
<b>Cladding</b>					
White*	Nail	C204	30mm	1	600mm to 2 storeys 400mm 3 - 5 storeys
Foiled*	Nail	C204	30mm	1	400mm

\* Ensure plank ends are always nailed

## Expansion Gaps

Always leave a minimum 4mm expansion gap at the end of each board, ie where two boards meet leave 8mm overall.

## Sealants

Use a low modulus silicone (BS 5889 Type A). Use a primer when bonding to GRP, stainless steel, aluminium or untreated wood. Do not use with polycarbonate sheet.

## Asbestos

By law all asbestos materials must be removed by trained operatives under strictly controlled conditions. If you suspect that asbestos is present you should consult your Local Authority.

## Ventilation

IMPORTANT - Roof voids must be ventilated in order to stop warm air condensing on cold surfaces. Condensation encourages rot and mould growth.

Foiled cladding installations can suffer from expansion and contraction due to heat absorption, therefore it is important to provide a free air path between vertical battens. Continuity of this ventilation path can be achieved by venting into the eaves or by leaving a 10mm air gap between the cladding and soffit.

## Current Ventilation Requirements

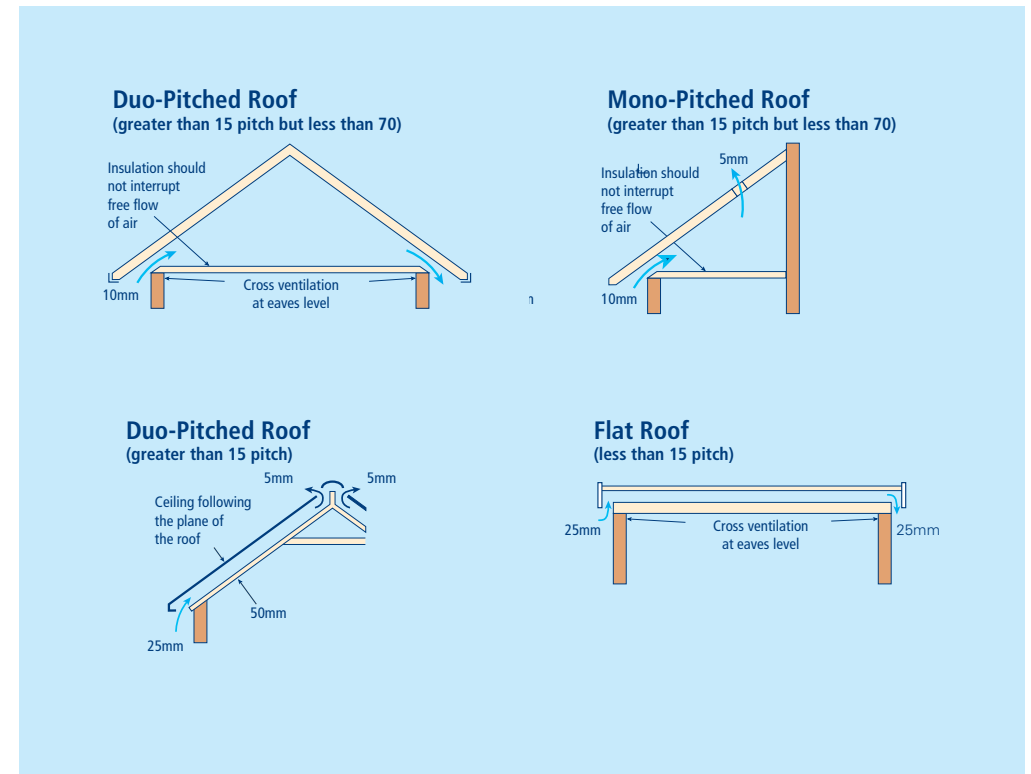

### Preparation Checklist

- Use proper access equipment (p28).
- Inspect for asbestos (p29).
- Push back the lower rows of tiles.
- Remove enough gutter, fascia, and soffit for one day's work only.
- Inspect rafters/laths and replace rotted timbers.
- Set up fixing points at maximum centres: white 600mm, foiled 400mm.
- Make sure ventilation is sufficient (p29).

- A. Cut back rotted felt to a clean edge.
- B. Fit suitable timber hangers (preservative treated) to support soffit boards. Screw hangers to rafter sides checking for level. Deep soffits must be nailed up every 200mm max across their depth. Set up support at hipped corners.
- C. Set up string lines to check vertical/horizontal faces of rafter feet and hangers for straight and level.
- D. Nail soffit board to hanger. Inner edge of soffit abuts to wall or sits on bricks. Outer edge of soffit should over hang by 10mm to fit groove in back of fascia board.
- E. Nail fascia board to rafter feet (check fixings p28) with sufficient height to create tile kick.
- F. Make soffit and fascia joints **between** rafters.
- G. Fit a dpc material under the existing felt. New material must dress into the gutter.
- H. Fit gutter brackets directly to replacement fascias of 16mm and above, in accordance with manufacturer's recommendations. Ensure correct fall in the gutter towards the down pipe.
- I. Box end construction. See p32.

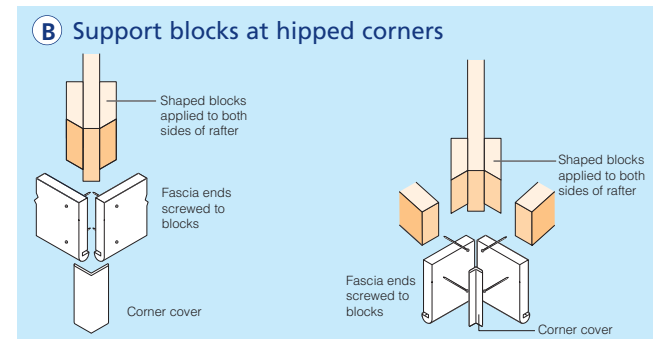
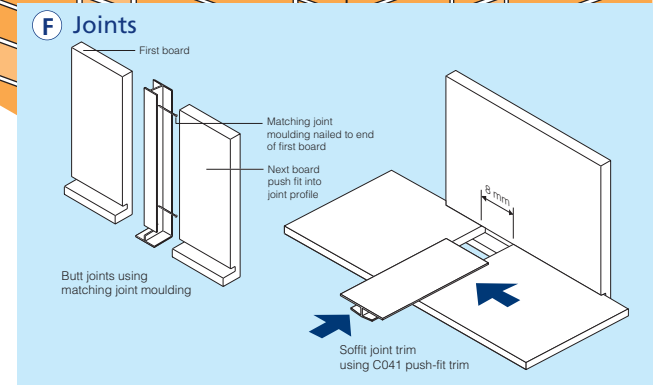
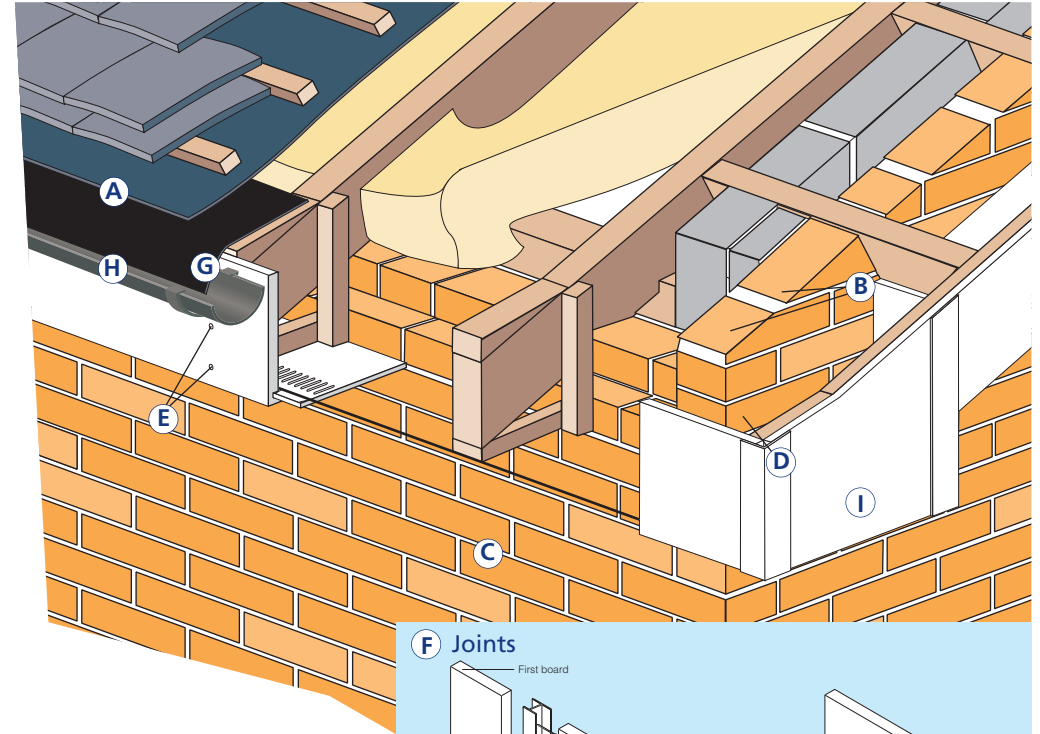

### Notes for Over – Capping

1. Check the expansion gaps and fixing centres detailed on page 28/29.
2. All over-capped timber **must** be sound.
3. The existing timber fascia must support the weight of tiles and the guttering.



## Box End Construction

- A. Finish fascia level with the face of the rafter gable. Soffit should over hang by 10mm and may be cut square or mitred.

**Note:** Timber hangers should be installed as required to locate box end structure.

- B. Measure and cut box end from a deep board. Front edge should tilt up to match height of fascia board.  
 C. Measure and cut fascia to form the return to gable wall.  
 D. Remove section from corner joint to fit around rafter.  
 E. Fix bargeboard directly to gable rafter.

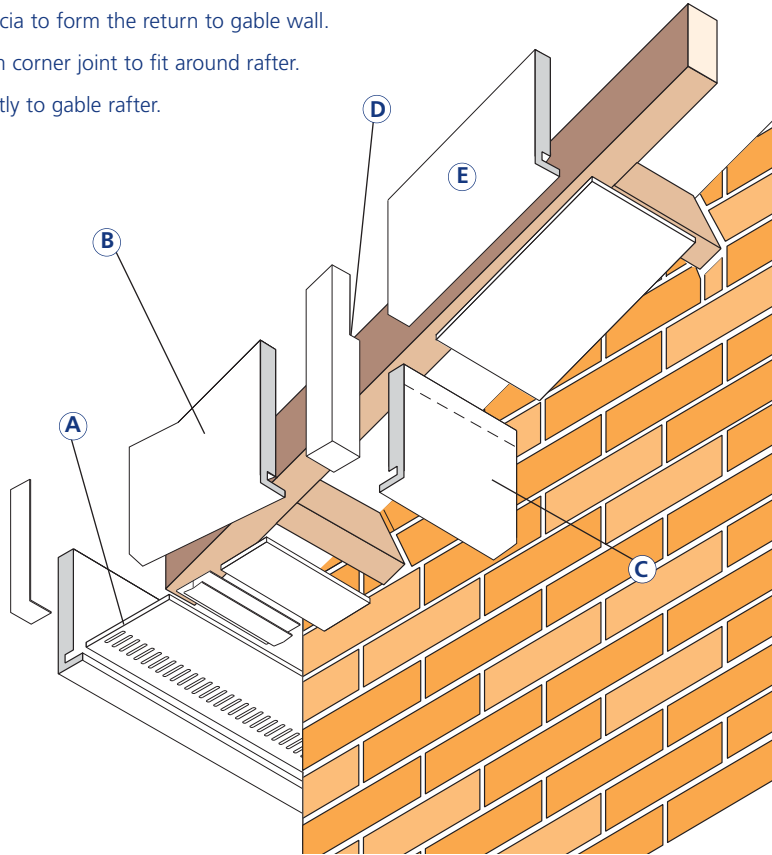

## Box End Construction Options

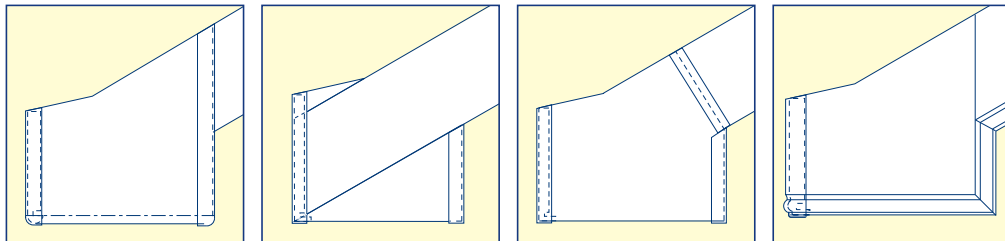

## Window Boards & Trims

### General

- Fix to dry, sound timber or masonry with a general purpose adhesive, where necessary, using stainless steel plastic headed screws or nails.
- Do not fix to damp surfaces. If there is any risk of damp after fixing, use a low modulus silicone.
- Rotten or damaged timber should be replaced before over capping. On irregular surfaces use packing pieces where needed.

- A. Window board; choice of:  
 16mm Bullnose (replacement unit)  
 9mm Bullnose Window Board (capping)  
 9mm Reveal/Cover Board (capping)  
 Keyboard Board (replacement)
- B. End cap, cut to suit (P17 and P24)
- C. Choice of Trims (See P16 and P22)  
 12mm Quadrant featured PQ012 (P16 and P22)  
 alternatively Window board Channel C037 (P15)
- D. 9mm Reveal Liner (Flat Board or Cover Board) (P14 and 15)
- E. Architrave Trims (See P17 and P22)
- F. Skirting Profiles (See P17 and P22)
- G. External Cill (See P26)

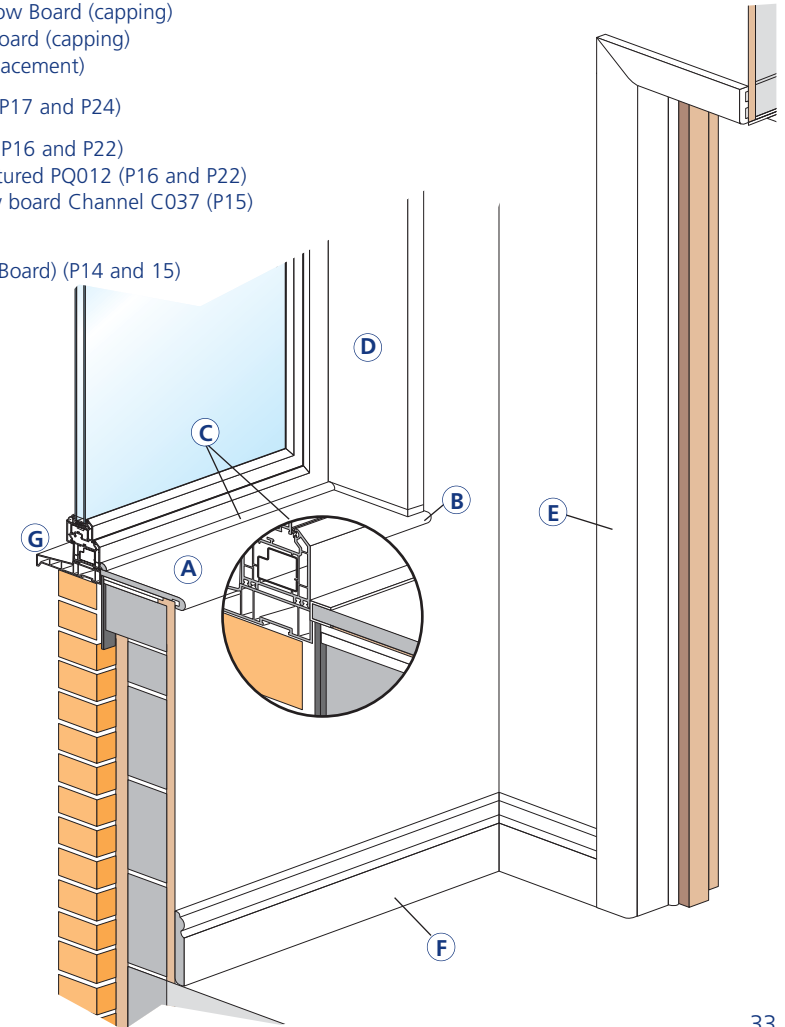

## Cladding Installation Sequence of Work

- A. Perimeter frame battens (recommended 25mm x 38mm)
- B. Battens around openings.
- C. Intermediate vertical battens.
- D. Starter trims (or bottom angle ventilation strip, as appropriate, see inset illustrations).
- E. Vertical perimeter trims, corner trims (where two-part trims are used, fix only the inner part).
- F. Top perimeter trims (These engage inside the vertical trims).
- G. Packings to battens as required for any cut planks.
- H. Plank profiles and joint covers or centre joint trims as appropriate (see p 13).
- I. Outer components of two-part trims.

### Notes:

For maximum fixing centres see p 28.

Use ventilator C065 to create continuous air gap behind the cladding.

Recommended min. batten depth to create ventilation path behind cladding panels:  
 White cladding = 25mm  
 Coloured cladding = 50mm

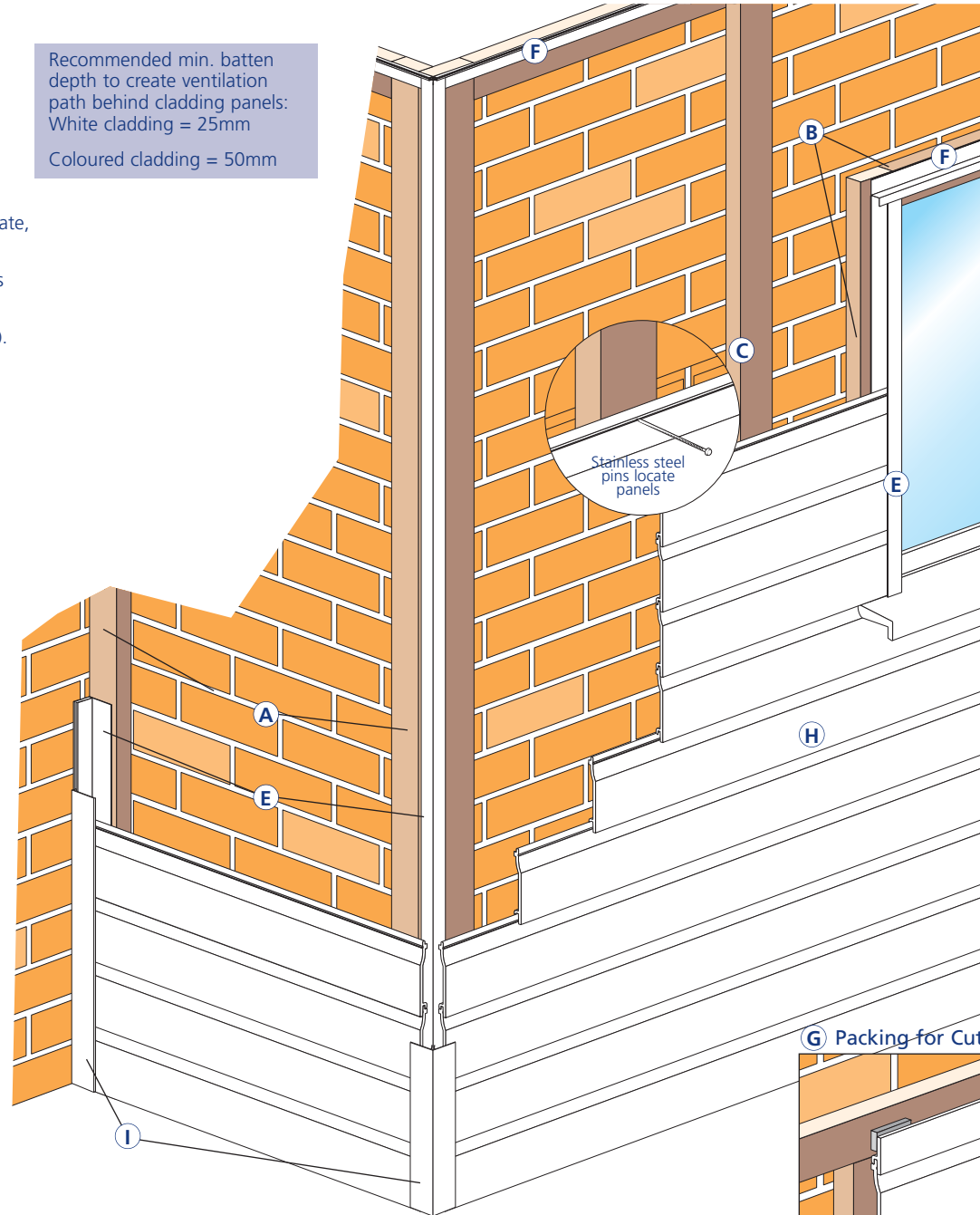

### D Starter Trims

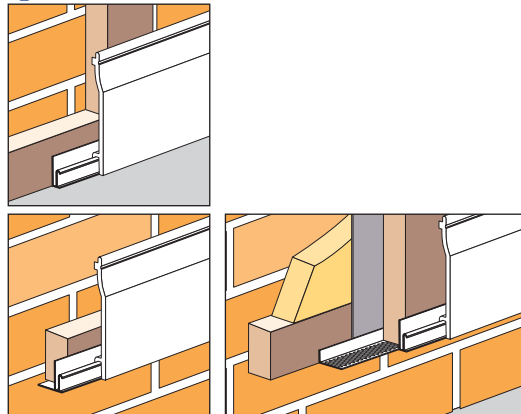

### E Trim Options

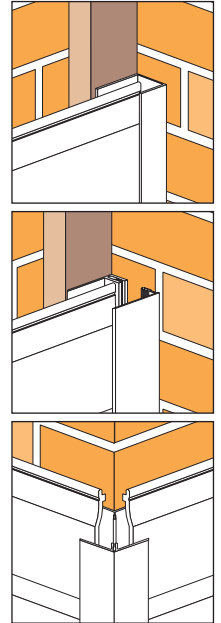

### H Joint Options

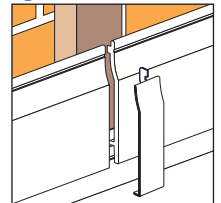

### G Packing for Cut Planks

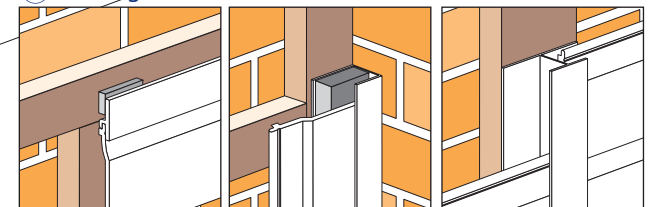

This installation guide is intended to provide a basic outline of the methods employed in installing Summit PVC Roofline and Cladding Products.

For further technical guidance  
please contact us on 01827 317200.

For further details contact:



Pioneer House  
Lichfield Road Ind. Estate,  
Tamworth, B79 7TF

Tel: (01827) 317200 Fax: (01827) 317201

[www.summitpvc.co.uk](http://www.summitpvc.co.uk)